



ACCESSORY FITMENT INSTRUCTION

Product	Fiat Fullback Nudge with Oval X-member	
Part no.	310010T	
	60 Minutes	Models : DCAB
		Page 1 of 6
		Date : 13/06/2016

DIAGRAM



Kit content:

	Qty	Description		Qty	Description
A	4	M10x90 Sets	I	2	M8 Hex nuts
B	6	M10 Hex nuts	J	2	M10x25x1.25 Sets (Fine thread)
C	10	M10 Spring washers	K	2	M10x40x3 flat washers
D	14	M10x30x2 Flat washers	L	2	Top mounting brackets (PS and DS)
E	2	M10x40 Sets	M	2	Bottom mounting brackets (PS and DS)
F	2	M8x25 Sets	N	2	T-bolts
G	4	M8x20x1.6 Flat washers	O	1	Nudge Bar
H	2	M8 Spring washers			

Additional equipment/Material needed for fitment :

Qty			
		Ratchet set	
		Spanner Set	
		Torque wrench	

Precautions during fitment:

Do not scratch the vehicle during fitment. Do not scratch the nudge when unpacking and during fitment.

Directions for use:

Follow the steps in this fitting instruction from step 1 - 10.

Fitment Instruction: Fullback Nudge

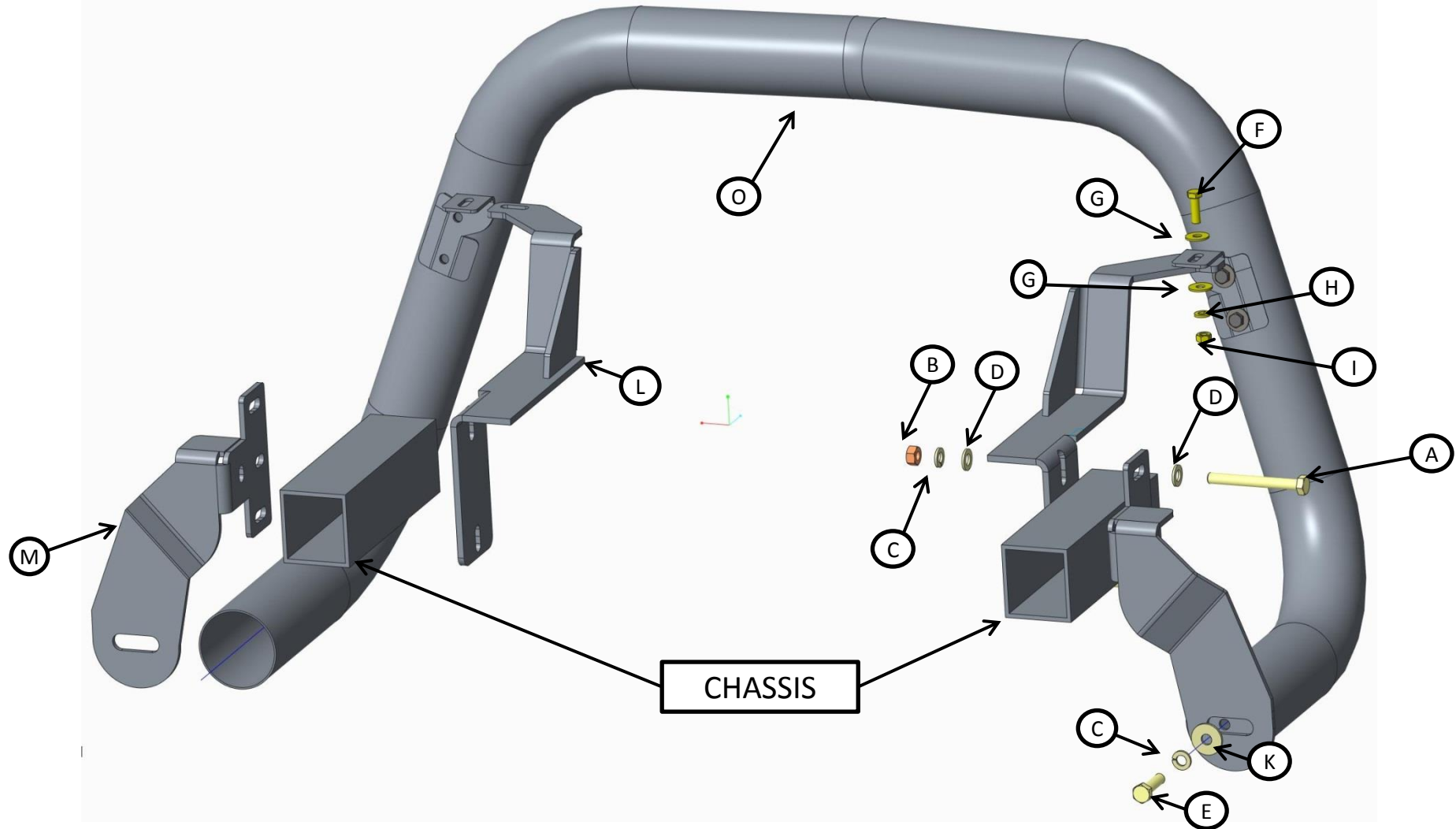



Fitment Instruction: Fullback Nudge

Visual / Graphic Illustration

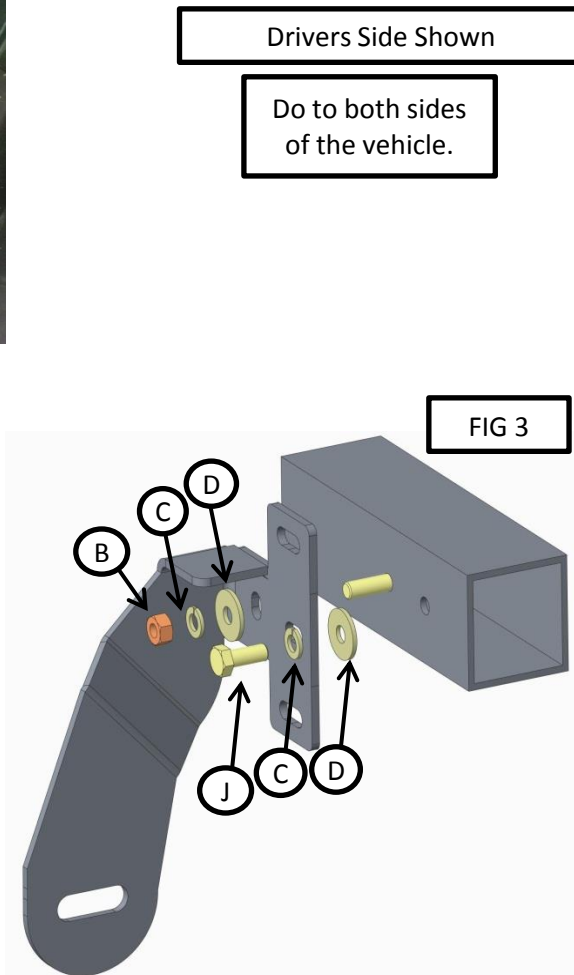
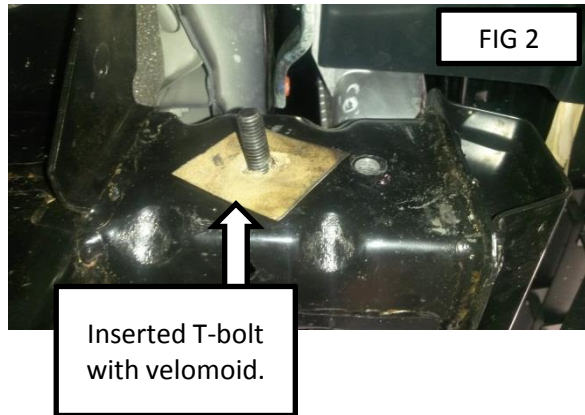
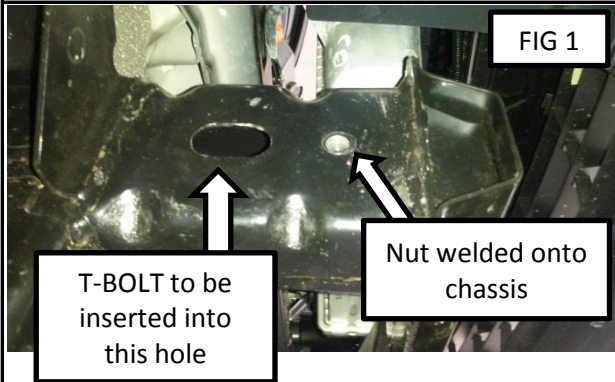

Step #	Description/Method
Step 1	Remove bottom covers from under the front bumper. You will install mounting brackets from the bottom of the vehicle.
Step 2	On the chassis find the holes needed for fitment. FIG 1. You will use the slotted hole and the threaded nut welded onto the chassis.
Step 3	Place the T-Bolt inside the slotted hole. Use the velomoid paper to hold the t-bolt in place. Shown in FIG 2.
Step 4	With the T-Bolt in place. Mount the bottom bracket on the outside of the chassis (FIG 3). Bracket marked with a P is for passengers side. D is for drivers side.



Fitment Instruction: Fullback Nudge

Visual / Graphic Illustration

FIG 4.1

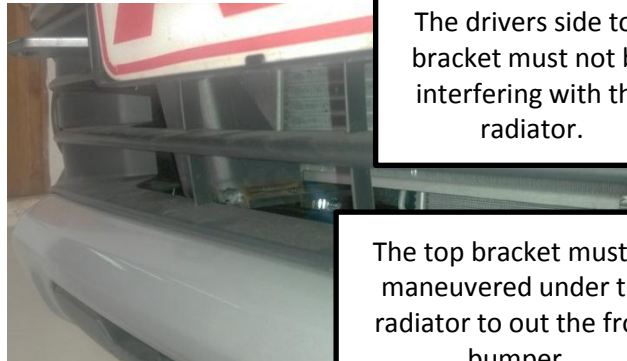
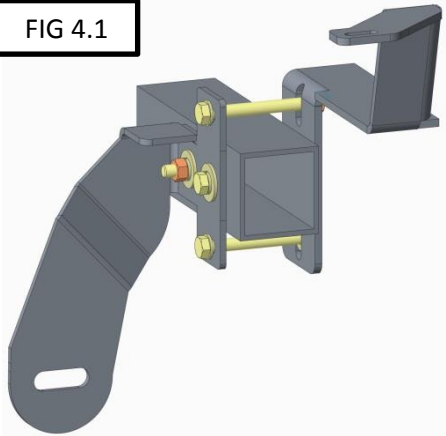

The drivers side top bracket must not be interfering with the radiator.

The top bracket must be maneuvered under the radiator to out the front bumper.

FIG 4.2

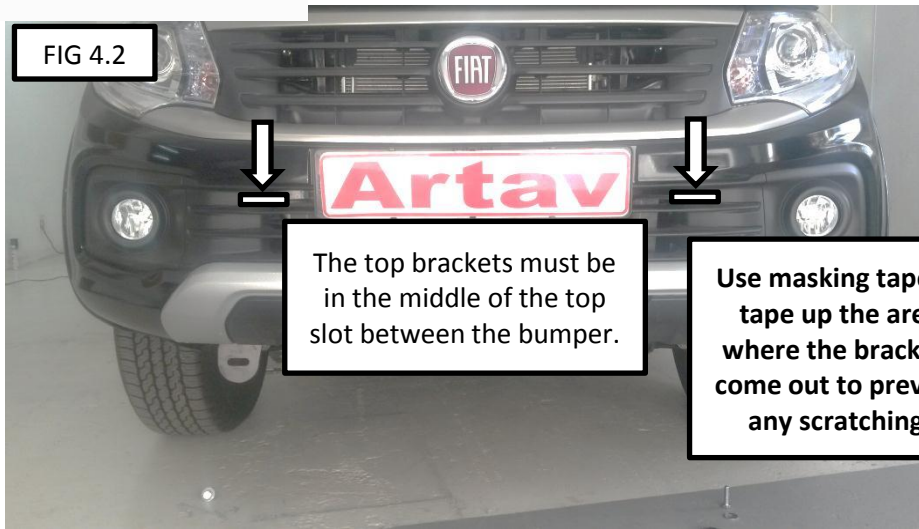

The top brackets must be in the middle of the top slot between the bumper.

Use masking tape to tape up the area where the brackets come out to prevent any scratching.

Step #	Description/Method
Step 5	With the bottom brackets now mounted. Mount the top bracket on the inside of the chassis, shown in FIG 4.1. The top of the brackets must be sticking out the front bumper, shown in FIG 4.2
Step 6	With the brackets in place. You can now mount the nudge onto them. The mounting brackets have slight adjustment if any is needed.
Step 7	Make sure the nudge is centered and aligned.
Step 8	Tighten all nuts and bolts to specified torque. Shown on the last page.



Fitment Instruction: Fullback Nudge

Visual / Graphic Illustration



Drivers side shown. Do to both sides of the vehicle.

Step #

Description/Method

Step 9

The bottom cover needs to be trimmed. Fig 5 shows where trimming is required.

Step 10

Replace all covers that were taken off in step 1.

COMPLETE

Make sure bar is centralised and tighten all fasteners to specified torque. M8= 22Nm , M10= 42Nm , M6= 9Nm.



WARRANTY

1. If any product manufactured by ARTAV is found to be defective during a period of twelve (12) months after the date of purchase , ARTAV shall repair (at ARTAV's discretion) the defective product or part.
2. Any defect in a product distributed by ARTAV , but not manufactured by ARTAV, shall be dealt with in accordance with , and to the extent of , the warranty offered by the manufacturer of the product.
3. ARTAV does not warrant that the products manufactured by it comply with the laws of the place where the products are being purchased or used. It is the responsibility of the purchaser to ascertain whether products being purchased - or affiliation of these products to any other object - comply with the local laws.
4. Except to the extent described in this warranty , ARTAV shall not be liable for any other claim , including those claims arising from faulty design , the use of the product on any indirect special or consequential damage or injury to any person , company or any other entity.
5. Modification or alteration to any product manufactured by ARTAV to enable fitment in conjunction with other vehicle accessories or modifications (eg lift kits) will void warranty claims.